



USER MANUAL : COOKER HOOD

**EFT7516K
EFT7516X
EFT9516K
EFT9516X**

CONTENTS

Description	1
Installation	1
Installation Ducting Version.....	1
Installation Filtering Version	2
Operation	3
Warning	3
Wiring Diagram	4
Diagram	4
Warranty Condition	8

Thank you for choosing and using Electrolux home appliances.

Electrolux Group of Sweden is one of the world largest home appliances companies. With more than 65 million Electrolux products being used by millions of households worldwide each year, it is also the world largest manufacturer of kitchen electrical appliances. The group has sold more than 55 million kitchen products, which is equivalent to the combined heights of 5 Mount Everest. Besides that, more than 2/3 of the world star hotels use Electrolux professional kitchen equipment.

Clearly, the excellent achievement of Electrolux over the last 80 years has been widely recognized by 450 million families all over the world. Now, we are pleased to make some of the best products from this renowned brand available to consumers in Southeast Asia. To us, not only is Electrolux one of the most reliable brands in dealing with home appliances, it is also a brand that promises to bring innovative lifestyles to all families through its cutting edge technologies and excellent designs. For not only do they add a touch of elegance to your kitchen, but Electrolux products also makes cooking easier, more enjoyable and something to share with. Enjoy happy cooking now with Electrolux kitchen appliances!

Once again, we would like to extend our heartiest thanks to you for your trust in choosing Electrolux products!

Before installing or using this appliance, please read this instruction book carefully and pay particular attention to the safety warnings in the following page.

Should you have further enquiries regarding this appliance, kindly contact our Customer Care for advice. Please keep this instruction book for future reference and pass it on to any future owners of this appliance.

DESCRIPTION

The hood may be installed in the filtering or the ducting version.

Ducting version (Fig. 1): The hood aspirates the kitchen air saturated with fumes and odour, passes it through the grease filters and expels it to the outside through an outlet pipe. With this version the charcoal filters are not required.

Decide from the outset on the type of installation (filtering or ducting). For greater efficiency, we recommend you install the hood in the ducting version (if possible).

Filtering version (Fig.2): The hood aspirates the kitchen air saturated with fumes and odour. Purifies it through the grease filters and charcoal filters and returns clean air into the room. For constant efficiency, the charcoal filters must be replaced periodically.

INSTALLATION

-Before beginning installation, to better handle the hood, we advise removing the grease filters.

-To remove the grease filter/s (Fig.3), in line with the handle, push the stop inwards and pull the filter down.

INSTALLATION IN DUCTING VERSION:

-Before fixing, the outlet pipe for air evacuation to the outside must be installed. Use an outlet pipe with: - minimum indispensable length; -Minimum possible bends (maximum angle of bend:90°); -certified material (according to the state); _ an as smooth as possible inside. It is also advisable to avoid any drastic changes in pipe cross-section (recommended diameter: 155mm).

-Decide on the position of the hole for the air outlet: The hole may be in the wall or the ceiling, according to your requirements, but must be in vertical line with your hood. Bear in mind that the hood just expel air through the top opening A (Fig.4).

-Mounting the air outlet adapter to the top opening A by securing two screws. Bear in mind that the opening B(Fig.4) must be closed by two ventilation cover with 4 screws(Fig.5) then insert the nameplate into the ventilation covers(Fig.6).

-Drill the hole in the wall for the air outlet (163 mm diameter) referring to Fig.7 where the measurements for the various possibilities are indicated.

-Prepare a suitable power supply. For the electrical connection, follow all the other instructions on the other instructions on the page 3.

-Proceed with fixing the hood: Based on your requirements, you can fit the hood on the wall or on a wall unit of your kitchen. IMPORTANT: Respect the distance between the hob and lower part of the hood which must be at least 650 cm.

-Fixing to the wall:

Before fixing the hood to the wall, mount two mounting brackets to the hood from two side with 4 screws provided(Fig.8) and drill a hole of 163mm diameter in the wall unit (Fig.7). In any case, check the position of the power outlet and consider where the power cable will run, since a hole might have to be made in the wall unit to accommodate it. Draw a line on the wall in vertical line with your hob. Mark the 2 holes to be drilled in the wall, respecting the distances indicated in Fig. 7; Make the 2 holes and fit the 2 screw anchors provided then without screwing that 2 of screws down completely. Hang the hood on the 2 screws; tighten the 2 screws completely. Now proceed with connecting a flexible tube to the hood outlet adapter tight well by mounting 2 screws. Tube is not provided. Make the electrical connection.

Fitting under wall unit:

-Before fixing the hood under the unit, drill a hole of 163mm diameter in the wall unit (Fig.9). In any case, check the position of the power outlet and consider where the power cable will run, since a hole might have to be made in the wall unit to accommodate it. Drill 4 holes in the wall unit, respecting the distance indicate in Fig.9. Insert the 4 mounting screws however without screwing them completely. ---
-Push the hood up against the wall unit and screw 4 screws completely from inside the hood. Connect a flexible tube to the hood outlet adapter, tight well by using 2 screws. Tube is not provided. Make the electrical connection. Installation is now complete.

We recommend you:

-CHECK THAT THE FRONT OPENING B MUST BE CLOSED(Fig.5 and Fig.6)
-Also remember that the use of charcoal filter/s is not necessary with the ducting.
-If the hood features a panel type charcoal filter (Fig.11), remove the charcoal filter by first of all removing the two filter retainers A.

INSTALLATION IN FILTERING VERSION:

Prepare a suitable power supply. For the electrical connection, follow all the instructions on the "warnings" label

-The openings A on the hood (Fig.10) must be closed, since the air is re-circulated into the room through the front vents.

-Proceed with fixing the hood: Based on your requirements, you can fit the hood on the wall or on a wall unit of your kitchen. IMPORTANT: Respect the distance between the hob and lower part of the hood which must be at least 650 cm.

Fixing to the wall: before fixing the hood to the wall, mount two mounting brackets to the hood from two side with 4 screws(Fig.8). Check the position if the power outlet and consider where the power cable will run, since a hole might have to be made in the wall unit to accommodate it. Draw a line in the wall in vertical line with your hob. Mark the 2 holes to be drilled in the wall, respecting the distances indicated in Fig.7; fit the 2 screw anchors provided then without screwing that 2 of screws down completely. Hang the hood on the 2 screws, tighten the 2 screws completely. Now make the electrical connection.

Fitting under wall unit: Before fixing the hood to the wall unit, check the position of the power outlet and consider where the power cable will run , since a hole might have to be made in the wall unit to accommodate it. Drill 4 holes and insert the 4 mounting screws however without screwing them completely in the wall unit, respecting the distance indicated in Fig.9. Push the hood up against the wall unit and screw the 4 screws completely operating from inside the hood. Make the electrical connection. Installation is now complete.

We recommend you:

-CHECK THAT THE OPENING A MUST BE CLOSED;
-Also remember that charcoal filter/s must be used in the case of the filtering version: check to see whether such filters are already fitted; if necessary, proceed to fit as follows:
-If the hood features a panel type charcoal filter/s(Fig.11), position the charcoal filter and fit the two filter retainers to secure the charcoal filter.

Notice:

-Exhaust air must not be discharged into a flue which is used for exhausting fumes from appliance burning gas or other fuels.
-If the instructions for installation for the gas hob specify a greater distance than 650mm, this have to be taken into account.
-The regulations concerning the discharge of exhaust air have to be fulfilled.
-Flexible duct (Ø 150mm) is not included and is sold separately as accessory item.

OPERATION

Depending on the model, the unit is equipped with the following controls:

Controls as in Fig.12: A =Motor on pilot light; B =Light ; C = switch – speed III; D = switch – speed II; E = switch – speed I; F=Motor ON/OFF.

Grease filter/s:

Aluminum filter/s (Fig.11): there are aluminum mesh filters must be periodically cleaned, depending in extent of depending on extent of operation (at least every two months). Wash the filters with neutral detergent. To remove the filters, in line with the handle, push the stop inwards and pull the filter down (Fig.3).

Charcoal filter/s: the charcoal filters must be periodically replaced depending on extent of operation- on average every 3 months. To remove the charcoal filters, proceed as follows,
-remove the charcoal filter by first of all removing the two filter retainers A.(Fig.11)

Lighting:

-To access or change the incandescent lamps, As Fig.13 indicated, first of all kick off Catch C by pulling Catch B and screw-driver. Draw out the light cover C according to the direction of arrow(Fig.13) and remove the bulb itself.

Caution:

1. The surface, the cover of the incandescent bulbs may be hot. Take care when taking the replacement.
2. Bulbs may be hot. Take care when taking the replacement.
3. The light cover may be broken during replacement, please take care.

Electrical connection:

* Electrical wiring must be done by a qualified person(s) in accordance with all applicable codes and standards. Turn off electrical power at service entrance before wiring.

* If the supply cord is damaged, it must be replaced by the manufacturer, its service agent or similarly qualified persons in order to avoid a hazard.

* Do not use the plug and an extension cord other than the ones initially supplied with the hood.

* The earthing of this hood is compulsory. Do not remove ground prong of the plug.

Warning:

In certain circumstances electrical appliances may be a danger hazard.

* Do not check the status of the filters while the cooker hood is operating.

* Do not touch the light bulbs after appliance use.

* Do not disconnect the appliance with wet hands.

* Avoid free flame, as it is damaging for the filters and a fire hazard.

* Constantly check food frying to avoid that the overheated oil may become a fire hazard.

* Disconnect the electrical plug prior to any maintenance.

* Children don't recognize the risks of electrical appliances. Therefore use or keep the appliance only under supervision of adults and out of the reach from children.

* Don't use this product outdoor.

* This appliance is not intended for use by persons (including children) with reduced physical, sensory or mental capabilities, or lack of experience and knowledge, unless they have been given supervision or instruction concerning use of the appliance by a person responsible for their safety. Children should be supervised to ensure that they do not play with the appliance.

* There shall be adequate ventilation of the room when the range hood is used at the same time as appliances burning gas or other fuels.

* There is a fire risk if cleaning is not carried out in accordance with instructions.

* Do not flam under the range hood.

*The discharge air must not be discharged into a flue which is used for exhausting fumes from appliances burning gas or other fuels.

Wiring Diagram

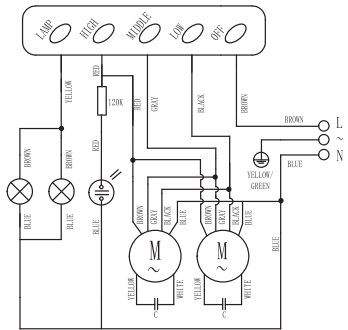

Product Dimension

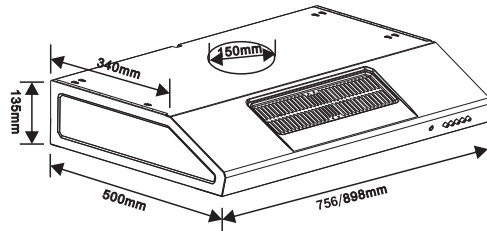

Fig 1

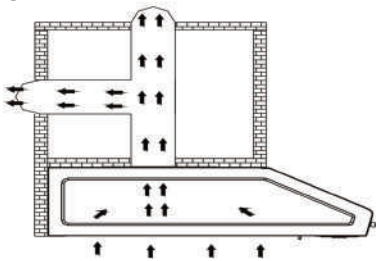

Fig 2

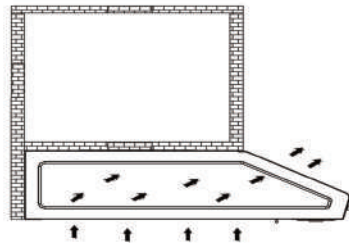

Fig 3

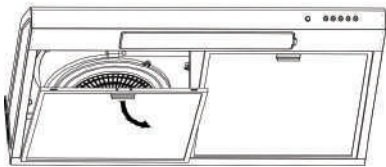

Fig 4

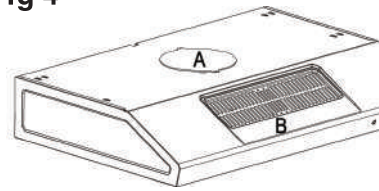

Fig 5

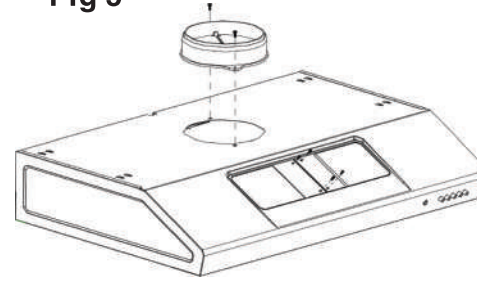

Fig 6

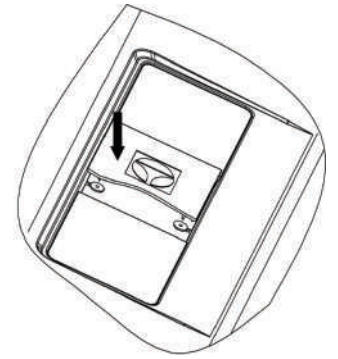

Fig 7

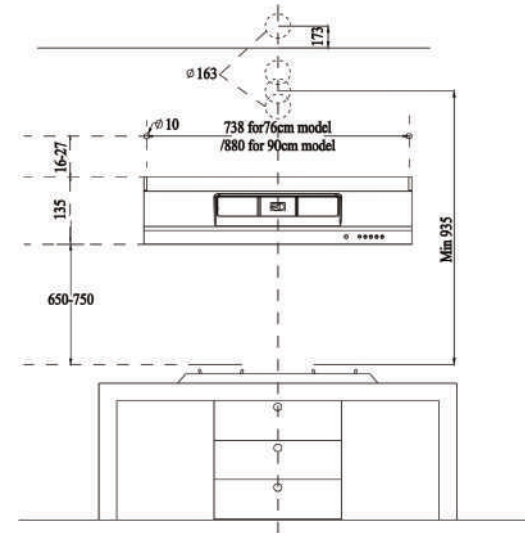

Fig 8

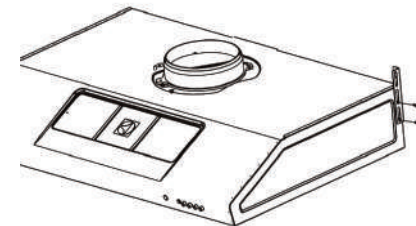

Fig 9

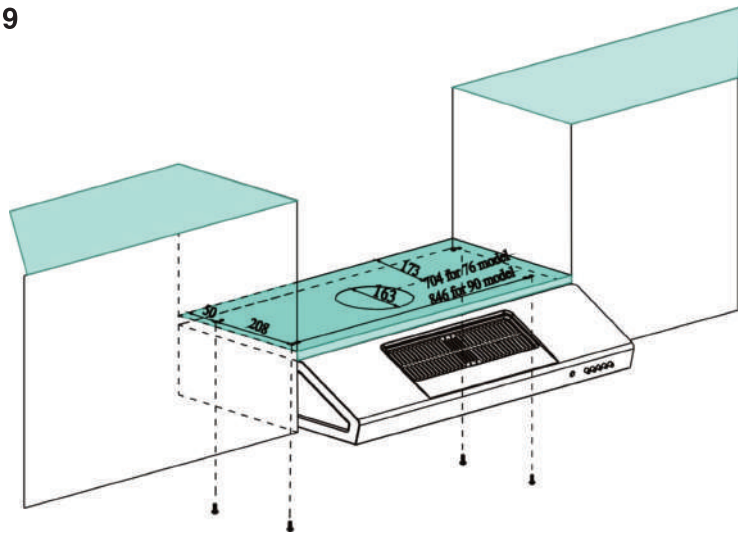

Fig 13

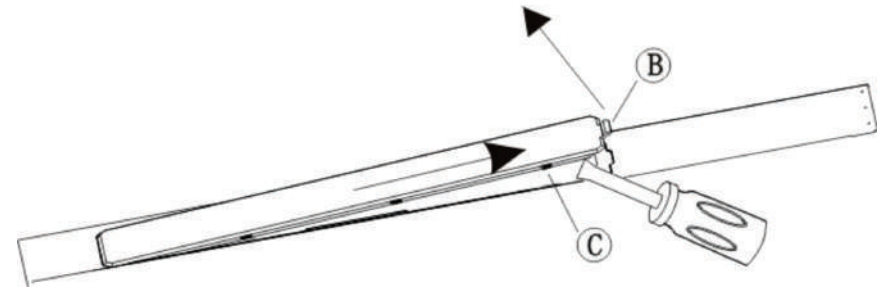

Fig 10

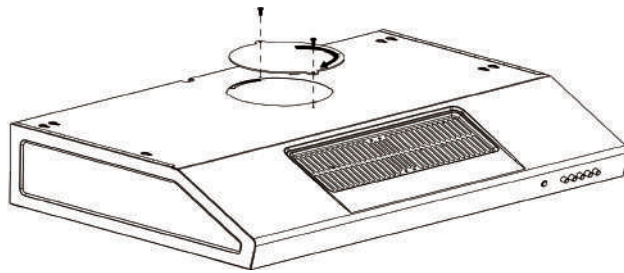

Fig 11

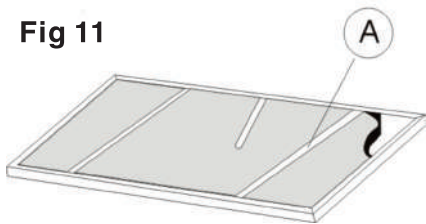
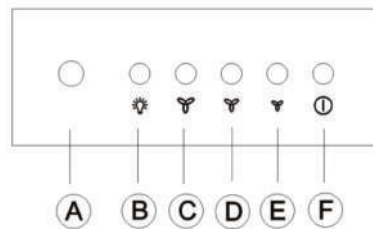

Fig 12



All parts & components must not be removed or replaced unless by qualified service personnel.

Standard warranty conditions

We, Electrolux, undertake that if within 12 months of the date of the purchase this Electrolux appliance or any part thereof is proved to be defective by reason only of faulty workmanship or materials, we will, at our option repair or replace the same FREE OF CHARGE for labour, materials or carriage on condition that:

The appliance has been correctly installed and used only on the electricity supply stated on the rating plate.

The appliance has been used for normal domestic purposes only, and in accordance with the manufacturer instructions. The appliance has not been serviced, maintained, repaired, taken apart or tampered with by any person not authorized by us.

All service work under this guarantee must be undertaken by an Electrolux Service Center. Any appliance or defective part replaced shall become the Company property. This warranty is in addition to your statutory and other legal rights.

This warranty does not include maintenance, like cleaning of hood.

The manufacturer waives all liability for failure to observe the instructions for the appropriate installation, maintenance and use of the appliance.

If you need any technical help or would like more information about our products, please do not hesitate to contact our Customer Care Center, listed below:

Thailand

Tel: (+66 2) 725 9000
Electrolux Thailand Co., Ltd.
14th Floor, 1910 New Petchburi Road
Bangkapi, Huay Kwang
Bangkok 10320

Indonesia

Hotline service: 08041119999
PT. Electrolux Indonesia
Electrolux Building
Jl.Abdul Muis No.34, Petojo Selatan,
Gambir Jakarta Pusat 10160
Email:customer care@electrolux.co.id
SMS & WA : 0812.8088.8863

Singapore

Tel: (+65) 6507 8699
e-mail: customer-care.sin@electrolux.com.sg
Electrolux S.E.A Pte. Ltd.
11 Lorong 3 Toa Payoh, Jackson Square Block B, #01-13/14/15
Singapore 319579

Vietnam

Toll Free: 1800-58-88-99
Tel: (+84 8) 3910 5465
Electrolux Vietnam Ltd .
AB Tower, 9th Floor
76 Le Lai Street, District 1
Ho Chi Minh City

Philippines

Toll Free: 1800-10-845-2273
Tel: (+63 2) 845 2273
Electrolux Philippines Inc.
25th Floor, Equitable Bank Tower 8751
Paseo De Roxas, Makati
Office Tel: (+63 2) 845 4510

Malaysia

Toll Free: 1300-88-11-22
Tel: (+60 3) 7843 5999
e-mail: customer.care@electrolux.com.my
Electrolux Home Appliances Sdn. Bhd.
7th Floor, Tower 2, Jaya 33,
No 3. Jalan Semangat, Seksyen 13,
46100 Petaling Jaya, Selangor

www.electrolux.com

The Thoughtful Design Innovator.

Do you remember the last time you opened a gift that made you say, "Oh! How did you know? That's exactly what I wanted!" That's the kind of feeling that we at Electrolux seek to evoke in everyone who chooses or uses one of our products. We devote time, knowledge, and a great deal of thought to anticipating and creating the kind of appliances that our customers really need and want.

This kind of thoughtful care means innovating with insight. Not design for design's sake, but design for the user's sake. For us, thoughtful design means making appliances easier to use and tasks more enjoyable to perform, freeing our customers to experience the ultimate 21st century luxury: ease of mind. Our aim is to make this ease of mind more available to more people in more parts of their everyday lives, all over the world.

The "Thinking of you" promise from Electrolux goes beyond meeting the needs of today's consumers. It also means we're committed to making appliances safe for the environment—now and for future generations.

Electrolux. Thinking of you.

Share more of our thinking at
www.electrolux.com